

2021

CATALOGUE DE PIÈCES



Synetik
ErgoCare

Table des matières

Appui-tête	4-6
Mécanisme d'ancrage d'appui-tête	6-7
Support d'appui-tête	8
Accessoire pour appui-tête	9
Support de butée thoracique	10
Support de butée d'abduction	10
Plastron	10
Ancrage	11-12
Accessoire pour ceinture	13-14-15
Coussinet de gel cubique	16
Coussinet de gel plat	16
Support de table & demi-table	17-18
Support de pied & accessoire	19-20
Ancrage d'appui-tête	21
Équerre	22
Manette	23-24

Table des matières

Appui-épaule	26
Réceptacle de support thoracique	26
Sangle coussinée	26
Butée thoracique	27
Butée abduction	27
Butée de hanche	28
Support de genou	29
Système pour jambe	30
Ensemble de conversion	30
Repose-pied	30
Table	31
Demi-coussin de table	31
Poignée de manutention	31
Mentonnière coussinée	31
Tablier coussinée	32
Appui-tête ventral	32
Harnais thoracique	32
Support de pied	32
Courroie pour orteils	32

APPUI-TÊTE



022-00001-4

Appui-tête souple
avec rotule 1"

4" H. x 9 1/2"



022-00001-5

Appui-tête souple
avec rotule 1"

5" H. x 10"



022-00001-6

Appui-tête souple
avec rotule 1"

6" H. x 10 1/2"

SOUPLE



022-00002-4

Appui-tête souple
avec rotule 1"

4" H. x 9 1/2"



022-00002-5

Appui-tête souple
avec rotule 1"

5" H. x 10"



022-00002-6

Appui-tête souple
avec rotule 1"

6" H. x 10"

FERME



022-00004-4

Appui-tête malléable de
4" de haute-densité
souple avec rotule 1"



022-00004-5

Appui-tête malléable de
5" de haute-densité
souple avec rotule 1"



022-00004-6

Appui-tête malléable de
6" de haute-densité
souple avec rotule 1"

MALLÉABLE

APPUI-TÊTE

LATÉRAUX MALLÉABLES



022-00003

Appui-tête avec
latéraux malléable
densité souple



022-00005-14

Appui-tête réglable
multi-angle 4 1/2"

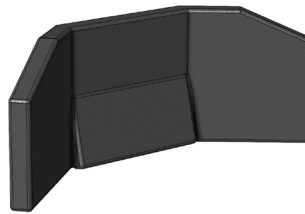

022-00005-16

Appui-tête réglable
multi-angle 5"



022-00005-17

Appui-tête réglable
multi-angle 5 1/2"

RÉGLAGE MULTI-ANGLE



022-00007

Appui-tête très grande
avec rotule 1"
6" H. x 16"

GRAND FORMAT

HOUSSE DE RECHARGE POUR APPUI-TÊTE



038-00002-4

Housse d'appui-tête

3 1/2" X 6"



038-00002-4

Housse d'appui-tête

4 1/2" X 7"



038-00002-6

Housse d'appui-tête

5 1/2" X 8"

RÉGLAGE MULTI-ANGLE

MÉCANISME D'ANCRAGE APPUI-TÊTE



021-00005-1

Mécanisme d'ancrage
7/8" fixe d'appui-tête
extensible 12" à 15"



021-00005-2

Mécanisme d'ancrage
1" fixe d'appui-tête
extensible 12" à 15"



021-00005-4

Mécanisme d'ancrage
1" fixe d'appui-tête
extensible 15" à 20"



021-00005-3

Mécanisme d'ancrage
7/8" fixe d'appui-tête
extensible 15" à 20"

FIXE

MÉCANISME D'ANCRAGE APPUI-TÊTE



021-00006

Barre de tension
avec "U"

BARRE DE TENSION



021-00003-1

Mécanisme d'ancrage
amovible d'appui-tête
extensible 15" à 20"



021-00003-2

Mécanisme d'ancrage
amovible d'appui-tête
extensible 12" à 15"

AMOVIBLE

SUPPORT APPUI-TÊTE



020-00001-A

Support d'appui-tête multidirectionnel droit (gris)



020-00004-N

Support d'appui-tête multidirectionnel 45° (noir)



020-00004-A

Support d'appui-tête multidirectionnel 45° (gris)



020-00005-4

Support d'appui-tête multidirectionnel double 4'' (gris)

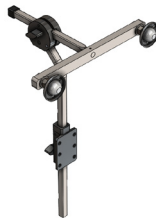

020-00005-9

Support d'appui-tête multidirectionnel double 9'' (gris)



020-00006

Support d'appui-tête multidirectionnel à pivot (gris)



020-00007

Support d'appui-tête 90° (gris)



020-00008

Support d'appui-tête multidirectionnel (gris)



020-00009

Support d'appui-tête déporté (gris)



020-00010

Support d'appui-tête multidirectionnel 45° sans ancrage (gris)



020-00014

Support d'appui-tête 90° sans ancrage (gris)

ACCESSOIRE POUR APPUI-TÊTE



039-00001

Tige d'appui-tête 8"

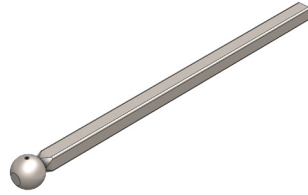

039-00009

Tige d'appui-tête 12"

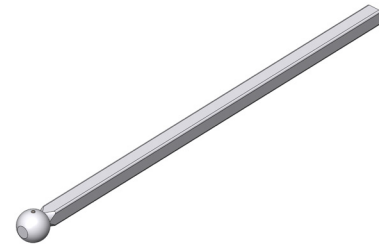

039-00003

Tige d'appui-tête 15"

TIGE D'APPUI-TÊTE



039-00011

Tige horizontale
d'appui-tête à fixation
ronde



039-00010

Tige horizontale
d'appui-tête à fixation
courbée

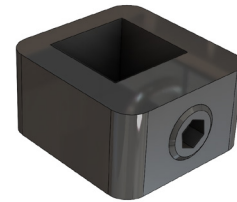

039-00002

Collier d'arrêt 1/2"

COLLIER D'ARRÊT

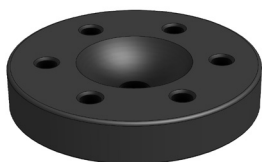

039-00013

Rondelle de serrage
pour pivot 1"
(2" Ø x 7/16")

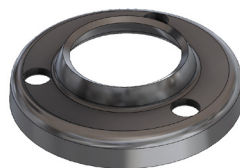

039-00014

Rondelle de serrage
pour pivot 1"

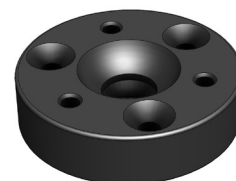

039-00015

Rondelle de serrage
pour pivot 1"
(2" Ø x 1/2")

RONDELLE DE SERRAGE

SUPPORT DE BUTÉE

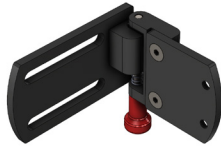

060-00001-L

Butée thoracique
pivotante gauche



060-00001-R

Bute thoracique
pivotante droite

THORACIQUE



080-00002

Support de butée
d'abduction à
bascule robuste



080-00003

Support de butée
d'abduction à bascule

ABDUCTION



084-00001

Plastron 4"x6"



084-00002

Plastron 5"x7"



084-00003

Plastron 6"x8"



084-00004

Plastron 7"x9"

PLASTRON

ANCRAGE



160-00020

Bloc d'ancrage 1/2"
à prise 3/4"



160-00021

Bloc d'ancrage 1/2"
à prise 7/8"



160-00022

Bloc d'ancrage 1/2"
à prise 1"

BLOC 1/2"



160-00007

Bloc d'ancrage 1"
à prise 3/4"



160-00008

Bloc d'ancrage 1"
à prise 7/8"



160-00009

Bloc d'ancrage 1"
à prise 1"

BLOC 1"

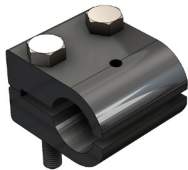

160-00025

Bloc d'ancrage 1 1/2"
à prise 3/4"



160-00015

Bloc d'ancrage 1 1/2"
à prise 7/8"



160-00016

Bloc d'ancrage 1 1/2"
à prise 1"

BLOC 1 1/2"



160-00013

Bloc d'ancrage 2"
à prise 3/4"



160-00024

Bloc d'ancrage 2"
à prise 7/8"



160-00014

Bloc d'ancrage 2"
à prise 1"

BLOC 2"

ANCRAGE



160-00004

Bloc d'ancrage 1 1/2"
à prise 3/4" (3 boulons)



160-00005

Bloc d'ancrage 1 1/2"
à prise 7/8" (3 boulons)

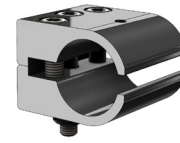

160-00006

Bloc d'ancrage 1 1/2"
à prise 1" (3 boulons)

BLOC 1 1/2"

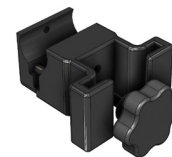

160-00023

Bloc d'ancrage latéral
à prise 7/8"

BLOC LATÉRAL

ACCESSOIRE POUR CEINTURE



085-00001-1

Ancrage pour
sangle 1"



085-00001-1.5

Ancrage pour
sangle 1 1/2"



085-00001-2

Ancrage pour
sangle 2"

ANCRAGE



085-00002

Passant pour
sangle 1" (zinc)

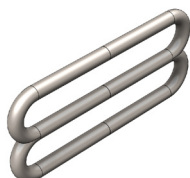

085-00003

Passant pour
sangle 1 1/2" (zinc)

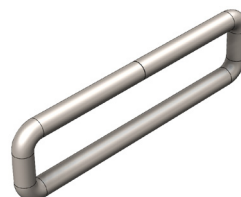

085-00004

Passant pour
sangle 2" (zinc)

PASSANT



085-C251P

Coussinet de
sangle 1"



085-C251M

Coussinet de
sangle 1 1/2"



085-C251L

Coussinet de
sangle 2"

COUSSINET DE SANGLE

ACCESSOIRE POUR CEINTURE



099-00002

Butée d'ancrage

7/8" x #10-32

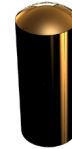

099-00034

Butée d'ancrage

3/8Ø x 15/16 (1/4-20)

BUTÉE D'ANCRAGE



099-00032

Boucle de plastique
1 1/2" bouton poussoir
latéraux



099-00033

Boucle de plastique
2" boutons poussoirs
latéraux

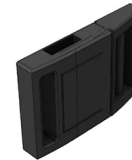

099-00010

Boucle de plastique
1" à boutons



099-00011

Boucle de plastique
1 1/2" à boutons



099-00031-S

Boucle de plastique
1" boutons poussoirs
latéraux simple



099-00031-D

Boucle de plastique
1" boutons poussoirs
latéraux double

BOUCLE DE PLASTIQUE

ACCESSOIRE POUR CEINTURE



099-00019

Boucle métal 1 1/2"
Type auto



099-00035

Boucle magnétique 1"
avec anneau en "D"



099-00021

Boucle métal 1 1/2"
Type auto avec
protection bouton
(clé de déverrouillage excluse)



099-00018

Boucle métal 2"
Type auto



099-00036

Boucle magnétique 1 1/2"
avec anneau en "D"



099-00020

Boucle métal 2"
Type auto avec
protection bouton
(clé de déverrouillage excluse)



099-00001

Clé déverrouillage
(s'utilise avec boucle métal
avec protection bouton)

BOUCLE

COUSSINET

GEL CUBIQUE

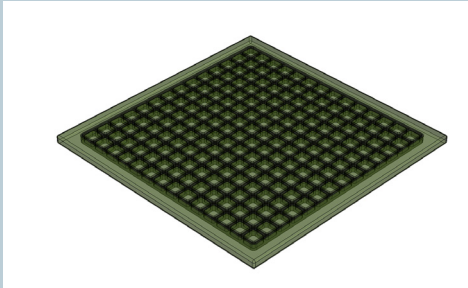

NUMÉRO DE PIÈCE	GRANDEUR
090-00001	9/16" X 16" X 16"
090-00002	9/16" X 16" X 18"
090-00003	9/16" X 18" X 18"

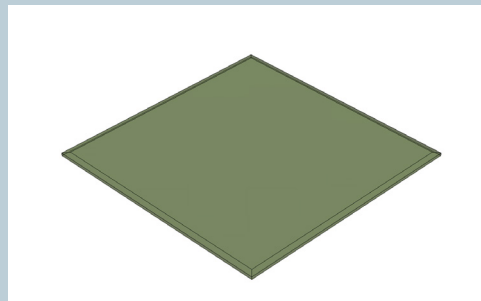

GEL PLAT

NUMÉRO DE PIÈCE	GRANDEUR
091-00001	1/4" X 16" X 16"
091-00002	1/4" X 16" X 18"
091-00003	1/4" X 18" X 18"
091-00004	1/4" X 18" X 20"
091-00005	1/4" X 20" X 20"
091-00006	3/8" X 16" X 16"
091-00007	3/8" X 16" X 18"
091-00008	3/8" X 18" X 18"
091-00009	3/8" X 18" X 20"
091-00010	3/8" X 20" X 20"
091-00011	1/2" X 16" X 16"
091-00012	1/2" X 16" X 18"
091-00013	1/2" X 18" X 18"
091-00014	1/2" X 18" X 20"
091-00015	1/2" X 20" X 20"

NUMÉRO DE PIÈCE	GRANDEUR
091-00016	5/8" X 16" X 16"
091-00017	5/8" X 16" X 18"
091-00018	5/8" X 18" X 18"
091-00019	5/8" X 18" X 20"
091-00020	5/8" X 20" X 20"
091-00021	3/4" X 16" X 16"
091-00022	3/4" X 16" X 18"
091-00023	3/4" X 18" X 18"
091-00024	3/4" X 18" X 20"
091-00025	3/4" X 20" X 20"
091-00026	1" X 16" X 16"
091-00027	1" X 16" X 18"
091-00028	1" X 18" X 18"
091-00029	1" X 18" X 20"
091-00030	1" X 20" X 20"

SUPPORT DE TABLE & DEMI-TABLE

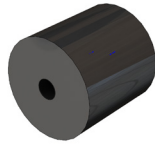

101-00010

Espaceur 1" Ø x 1"
LG. pour glissière de
table ajustable



101-00008

Support d'équerre
de table

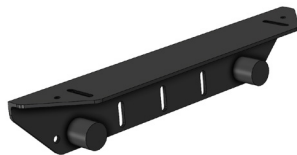

101-00009

Glissière de table
ajustable



101-00012

Glissière standard
13"
(incluant quincaillerie)



101-00013

Ensemble de (2)
glissières standards
12"

SUPPORT DE TABLE & DEMI-TABLE



101-00007

Support de demi-table
à double pivot et
ajustement latéral

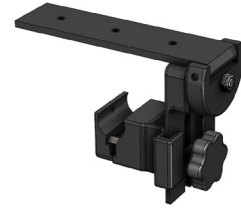

101-00011

Support de demi-table
à double pivot

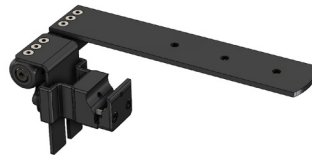

101-00014-LH

Support de demi-table
à pivot gauche



101-00014-RH

Support de demi-table
à pivot droite



C00307P

Clé de serrage
pour bâti de roues

DEMI-TABLE

OUTILS VERTICALISATEUR

SUPPORT DE PIED & ACCESSOIRE



140-00001-1

Ensemble (2) supports de pied 2 1/2" x 5 1/2" LG (gauche & droite)



140-00001-2

Ensemble (2) supports de pied 3" x 6 3/4" LG (gauche & droite)



140-00001-3

Ensemble (2) supports de pied 3 1/2" x 7 1/2" LG (gauche & droite)



140-00001-4

Ensemble (2) supports de pied 3 3/4" x 8 1/2" LG (gauche & droite)



140-00001-5

Ensemble (2) supports de pied 4" x 9 1/2" LG (gauche & droite)



140-00001-6

Ensemble (2) supports de pied 4 1/4" x 10 1/2" LG (gauche & droite)



140-00001-7

Ensemble (2) supports de pied 4 1/4" x 12" LG (gauche & droite)



140-00001-8

Ensemble (2) supports de pied 5" x 13" LG (gauche & droite)

SUPPORT DE PIED & ACCESSOIRE



140-00001-1TS

Ensemble courroies d'orteils pour support de pied #140-00001-01
(supports de pieds exclus)



140-00001-2TS

Ensemble courroies d'orteils pour support de pied #140-00001-2
(supports de pieds exclus)

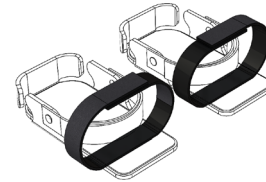

140-00001-3TS

Ensemble courroies d'orteils pour support de pied #140-00001-3
(supports de pieds exclus)

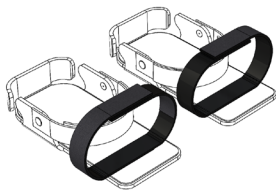

140-00001-4TS

Ensemble courroies d'orteils pour support de pied #140-00001-04
(supports de pieds exclus)



140-00001-5TS

Ensemble courroies d'orteils pour support de pied #140-00001-5
(supports de pieds exclus)



140-00001-6TS

Ensemble courroies d'orteils pour support de pied #140-00001-6
(supports de pieds exclus)

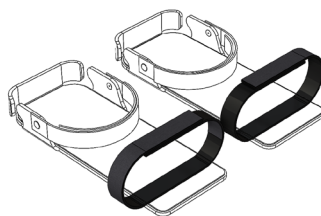

140-00001-7TS

Ensemble courroies d'orteils pour support de pied #140-00001-07
(supports de pieds exclus)

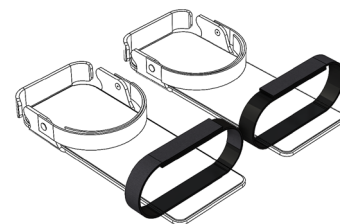

140-00001-8TS

Ensemble courroies d'orteils pour support de pied #140-00001-8
(supports de pieds exclus)

ANCRAGE



160-00019

Demi-plaque d'ancrage
pour profilé 1/2"



160-00018

Demi-plaque d'ancrage
pour profilé 5/8"

DEMI-PLAQUE



160-00003

Plaque d'ancrage 1/2"
pour dossier
ACTABACK BT38744



160-00001

Plaque d'ancrage
pour profilé 1/2"



160-00017

Plaque d'ancrage
pour profilé 5/8"

PLAQUE



160-00010

Plaque d'ancrage
pour profilé 1/2" à
prise 7/8"



160-00011

Plaque d'ancrage
pour profilé 1/2" à
prise 1"



160-00012

Plaque d'ancrage
pour profilé 1/2" à
prise 3/4"

PLAQUE AVEC PRISE

ÉQUERRE



163-00001

Équerre courte
2'' x 2 1/4'' (acier)



163-00002

Équerre longue
2'' x 3 3/8'' (acier)



163-00003

Équerre courte
1'' x 3 1/2'' (acier)



163-00004

Équerre 1/2'' x 16 1/2'' x 16 1/2''
(aluminium)

MANETTE



170-00008

Manette (2) lobes
M6 x 15 mm
(rondelle plate incuse)

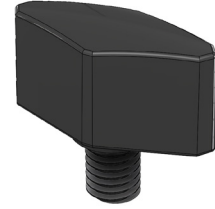

170-00005

Manette (2) lobes
M8 x 10 mm

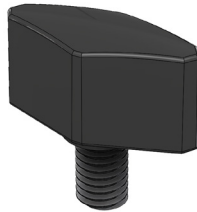

170-00006

Manette (2) lobes
M8 x 12 mm

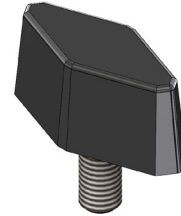

170-00007

Manette (2) lobes
1/4 - 20 x 1/2"



170-00009

Manette (4) lobes
1/4-20 x 1"

2 LOBES

4 LOBES

MANETTE

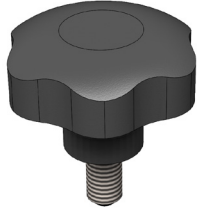

170-00004

Manette (6) lobes
1/4 - 20 x 1/2

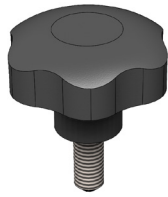

170-00001

Manette (6) lobes
1/4 - 20 x 5/8"

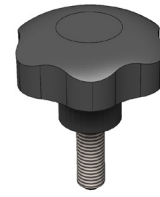

170-00002

Manette (6) lobes
1/4 - 20 x 3/4"

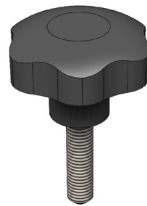

170-00003

Manette (6) lobes
1/4 - 20 x 1/2"



170-00010

Manette (6) lobes
1/4 - 20 x 1 1/2"

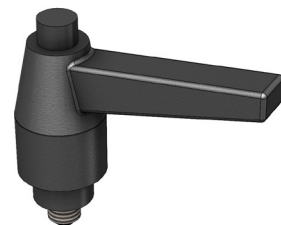

170-00011

Manette à levier
rétractable 1/4 - 20

6 LOBES

LEVIER

VERTIFLEX

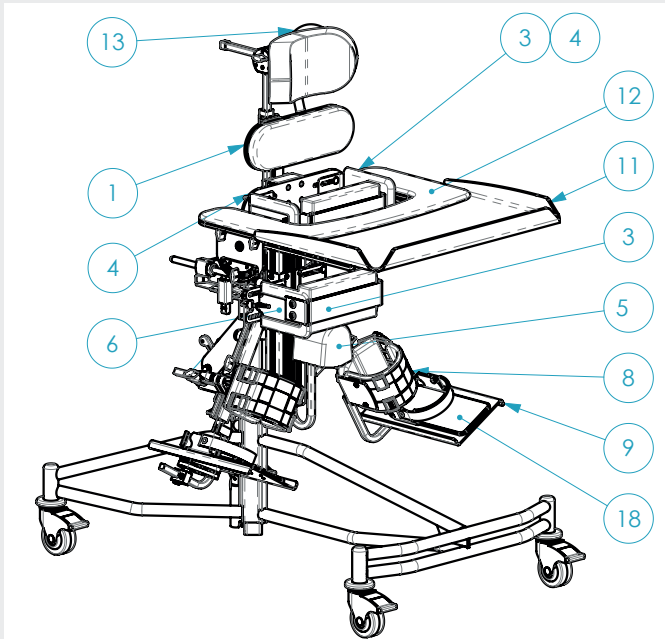

A1-2-3

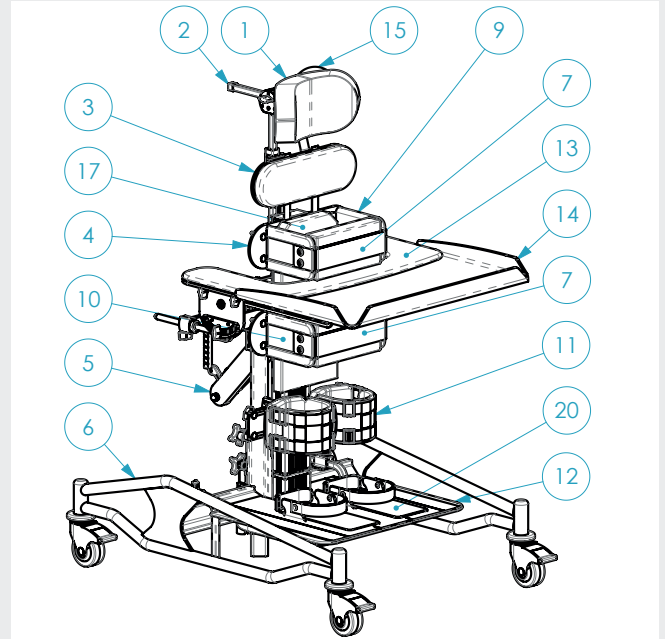

S1-2-3

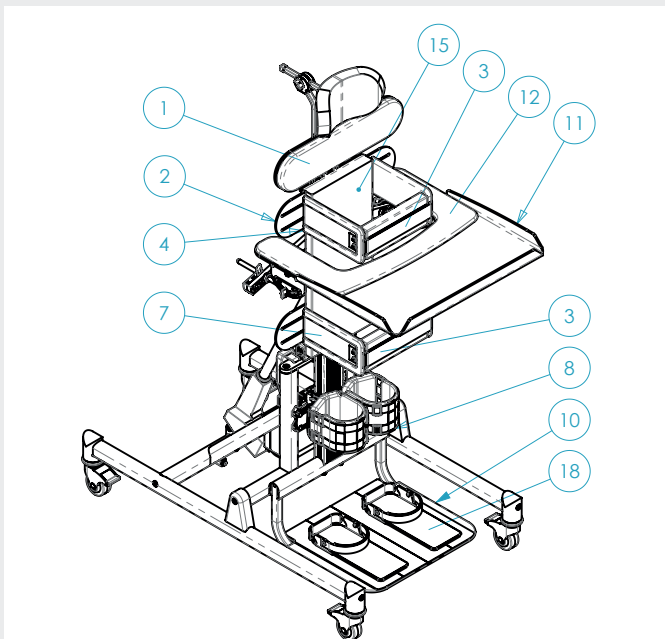

S4-5-6

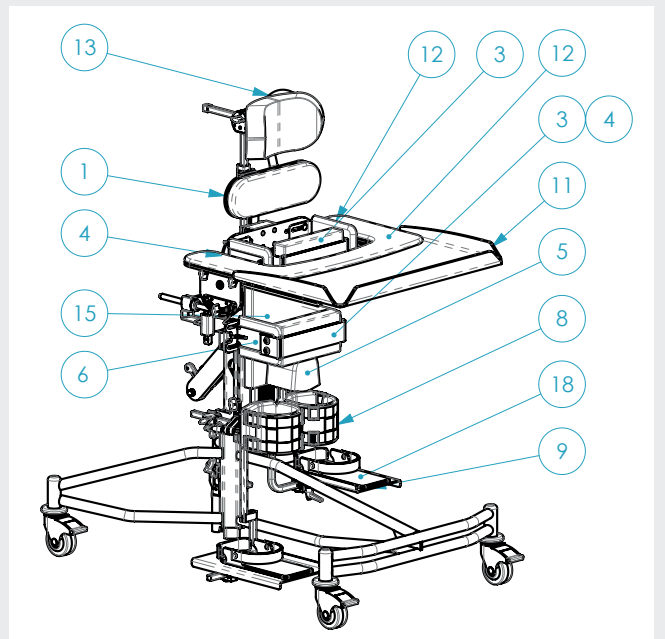

SA1-2-3

1

APPUI-ÉPAULE

Modèles hybride & dorsal



SOUPLE HANCHE

Numéro de produit	Grandeur	A1-2-3	S1-2-3	S4-5-6	SA1-2-3
019-00006-38	3 X 8 Lg.	√	√		
019-00006-310	3 X 10 Lg.	√	√		
019-00006-412	4 X 12 Lg.	√	√	√	
019-00006-516	5 X 16 Lg.	√	√	√	
019-00006-520	5 X 20 Lg.	√	√	√	
019-00006-524	5 X 24 Lg.			√	

2

SUPPORT DE BUTÉE THORACIQUE



INDÉPENDANT

Numéro de produit	Grandeur	A1-2-3	S1-2-3	S4-5-6	SA1-2-3
019-00066-B	Taille 1	√	√		√
019-00066-K	Taille 2	√	√		√
019-00066-J	Taille 3	√	√		√
019-00066-E				√	

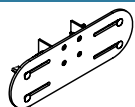

STANDARD

Numéro de produit	Grandeur	A1-2-3	S1-2-3	S4-5-6	SA1-2-3
019-00007-B	Taille 1	√	√		√
019-00007-K	Taille 2	√	√		√
019-00007-J	Taille 3	√	√		√
019-00007-E				√	

3

SANGLE COUSSINÉE



SOUPLE THORACIQUE

Numéro de produit	Grandeur	A1-2-3	S1-2-3	S4-5-6	SA1-2-3
019-00028-35	3 X 5 Lg.	√	√		√
019-00028-36	3 X 5 Lg.	√	√		√
019-00028-37	3 X 7 Lg.	√	√		√
019-00028-48	4 X 8 Lg.	√	√	√	√
019-00028-410	4 X 10 Lg.	√	√	√	√
019-00028-413	4 X 13 Lg.	√	√	√	√
019-00028-416	4 X 16 Lg.	√	√	√	√

SOUPLE HANCHE

Numéro de produit	Grandeur	A1-2-3	S1-2-3	S4-5-6	SA1-2-3
019-00029-35	3 X 5 Lg.	√	√		√
019-00029-36	3 X 5 Lg.	√	√		√
019-00029-37	3 X 7 Lg.	√	√		√
019-00029-48	4 X 8 Lg.	√	√	√	√
019-00029-410	4 X 10 Lg.	√	√	√	√
019-00029-413	4 X 13 Lg.	√	√	√	√
019-00029-416	4 X 16 Lg.	√	√	√	√

RIGIDE HANCHE (pour modèle ventral/hybride)

Numéro de produit	Grandeur	A1-2-3	S1-2-3	S4-5-6	SA1-2-3
019-00035-35	3 X 5 Lg.	√	√		√
019-00035-36	3 X 5 Lg.	√	√		√
019-00035-37	3 X 7 Lg.	√	√		√
019-00035-48	4 X 8 Lg.	√	√	√	√
019-00035-410	4 X 10 Lg.	√	√	√	√
019-00035-413	4 X 13 Lg.	√	√	√	√
019-00035-416	4 X 16 Lg.	√	√	√	√

4

BUTÉE THORACIQUE

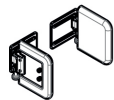

A-STANDARD

Numéro de produit	Grandeur	A1-2-3	S1-2-3	S4-5-6	SA1-2-3
019-00034-BK03	4 X 3 Lg.	√	√		√
019-00034-BK04	4 X 4 Lg.	√	√		√
019-00034-BK05	4 X 5 Lg.	√	√		√
019-00034-BK06	4 X 6 Lg.	√	√		√
019-00034-BK07	4 X 7 Lg.	√	√		√
019-00034-J05	5 X 5 Lg.	√	√	√	√
019-00034-J06	5 X 6 Lg.	√	√	√	√
019-00034-J07	5 X 7 Lg.	√	√	√	√
019-00034-J08	5 X 8 Lg.	√	√	√	√
019-00034-J09	5 X 9 Lg.	√	√	√	√
019-00034-J10	5 X 10 Lg.	√	√	√	√
019-00034-J11	5 X 11 Lg.			√	
019-00034-J12	5 X 12 Lg.			√	
019-00034-J13	5 X 13 Lg.			√	
019-00034-J14	5 X 14 Lg.			√	

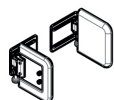

B-PIVOTANTE

Numéro de produit	Grandeur	A1-2-3	S1-2-3	S4-5-6	SA1-2-3
019-00041-BK04	4 X 4 Lg.	√	√		√
019-00041-BK05	4 X 4 Lg.	√	√		√
019-00041-BK06	4 X 5 Lg.	√	√		√
019-00041-BK07	4 X 6 Lg.	√	√		√
019-00041-J05	5 X 5 Lg.	√	√	√	√
019-00041-J06	5 X 6 Lg.	√	√	√	√
019-00041-J07	5 X 7 Lg.	√	√	√	√
019-00041-J08	5 X 8 Lg.	√	√	√	√
019-00041-J09	5 X 9 Lg.	√	√	√	√
019-00041-J10	5 X 10 Lg.	√	√	√	√
019-00041-J11	5 X 11 Lg.			√	
019-00041-J12	5 X 12 Lg.			√	
019-00041-J13	5 X 13 Lg.			√	
019-00041-J14	5 X 14 Lg.			√	

4

BUTÉE THORACIQUE

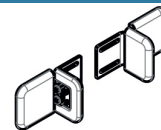

C-BLOQUEUR DE COUDE

Numéro de produit	Grandeur	A1-2-3	S1-2-3	S4-5-6	SA1-2-3
019-00042-BK03	4 X 3 Lg.	√	√		√
019-00042-BK04	4 X 4 Lg.	√	√		√
019-00042-BK05	4 X 5 Lg.	√	√		√
019-00042-BK06	4 X 6 Lg.	√	√		√
019-00042-BK07	4 X 7 Lg.	√	√		√
019-00042-J05	5 X 5 Lg.	√	√	√	√
019-00042-J06	5 X 6 Lg.	√	√	√	√
019-00042-J07	5 X 7 Lg.	√	√	√	√
019-00042-J08	5 X 8 Lg.	√	√	√	√
019-00042-J09	5 X 9 Lg.	√	√	√	√
019-00042-J10	5 X 10 Lg.	√	√	√	√
019-00042-J11	5 X 11 Lg.			√	
019-00042-J12	5 X 12 Lg.			√	
019-00042-J13	5 X 13 Lg.			√	
019-00042-J14	5 X 14 Lg.			√	

5

BUTÉE D'ABDUCTION



Numéro de produit	Grandeur	A1-2-3	S1-2-3	S4-5-6	SA1-2-3
019-00008-B	Taille 1	√	√		√
019-00008-K	Taille 2	√	√		√
019-00008-J	Taille 3	√	√		√
019-00008-SS	Taille 4			√	
019-00008-SM	Taille 5			√	
019-00008-SL	Taille 6			√	

BUTÉE HANCHE

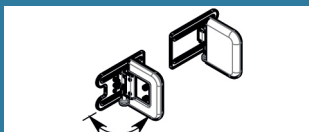

B-PIVOTANTE

Numéro de produit	Grandeur	A1-2-3	S1-2-3	S4-5-6	SA1-2-3
019-00036-BK04	4 X 4 Lg.	√			√
019-00036-BK05	4 X 5 Lg.	√			√
019-00036-BK06	4 X 6 Lg.	√			√
019-00036-BK07	4 X 7 Lg.	√			√
019-00036-J05	5 X 5 Lg.	√			√
019-00036-J06	5 X 6 Lg.	√			√
019-00036-J07	5 X 7 Lg.	√			√
019-00036-J08	5 X 8 Lg.	√			√
019-00036-J09	5 X 9 Lg.	√			√
019-00036-J10	5 X 10 Lg.	√			√
019-00045-BK04	4 X 4 Lg.		√		
019-00045-BK05	4 X 5 Lg.		√		
019-00045-BK06	4 X 6 Lg.		√		
019-00045-BK07	4 X 7 Lg.		√		
019-00045-J05	5 X 5 Lg.		√	√	
019-00045-J06	5 X 6 Lg.		√	√	
019-00045-J07	5 X 7 Lg.		√	√	
019-00045-J08	5 X 8 Lg.		√	√	
019-00045-J09	5 X 9 Lg.		√	√	
019-00045-J10	5 X 10 Lg.		√	√	
019-00045-J11	5 X 11 Lg.			√	
019-00045-J12	5 X 12 Lg.			√	
019-00045-J13	5 X 13 Lg.			√	
019-00045-J14	5 X 14 Lg.			√	

BUTÉE HANCHE

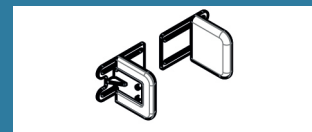

A-STANDARD

Numéro de produit	Grandeur	A1-2-3	S1-2-3	S4-5-6	SA1-2-3
019-00043-BK3	4 X 3 Lg.		√		
019-00043-BK4	4 X 4 Lg.		√		
019-00043-BK5	4 X 5 Lg.		√		
019-00043-BK6	4 X 6 Lg.		√		
019-00043-BK7	4 X 7 Lg.		√	√	
019-00043-J05	5 X 5 Lg.		√	√	
019-00043-J06	5 X 6 Lg.		√	√	
019-00043-J07	5 X 7 Lg.		√	√	
019-00043-J08	5 X 8 Lg.		√	√	
019-00043-J09	5 X 9 Lg.		√	√	
019-00043-J10	5 X 10 Lg.		√	√	
019-00043-J11	5 X 11 Lg.			√	
019-00043-J12	5 X 12 Lg.			√	
019-00043-J13	5 X 13 Lg.			√	
019-00043-J14	5 X 14 Lg.			√	
019-00053-BK3	4 X 3 Lg.	√			√
019-00053-BK4	4 X 4 Lg.	√			√
019-00053-BK5	4 X 5 Lg.	√			√
019-00053-BK6	4 X 6 Lg.	√			√
019-00053-BK7	4 X 7 Lg.	√			√
019-00053-J05	5 X 5 Lg.	√			√
019-00053-J06	5 X 6 Lg.	√			√
019-00053-J07	5 X 7 Lg.	√			√
019-00053-J08	5 X 8 Lg.	√			√
019-00053-J09	5 X 9 Lg.	√			√
019-00053-J10	5 X 10 Lg.	√			√

SUPPORT & BUTÉE À GENOU



A-SUPPORT STANDARD (SIMPLE BUTÉE)

Numéro de produit	Grandeur	A1-2-3	S1-2-3	S4-5-6	SA1-2-3
019-00032-B	Taille 1	√			√
019-00032-K	Taille 2	√			√
019-00032-J	Taille 3	√			√
019-00033-B	Taille 1		√		
019-00033-K	Taille 2		√		
019-00033-J	Taille 3		√	√	

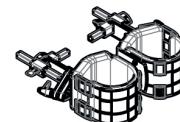

B - SUPPORT MULTI-AXES (SIMPLE BUTÉE)

Numéro de produit	Grandeur	A1-2-3	S1-2-3	S4-5-6	SA1-2-3
019-00030-B	Taille 1	√			√
019-00030-K	Taille 2	√			√
019-00030-J	Taille 3	√			√
019-00031-B	Taille 1		√		
019-00031-K	Taille 2		√		
019-00031-J	Taille 3		√		

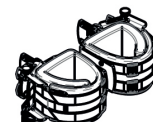

C - SUPPORT STANDARD DOUBLE BUTÉE

Numéro de produit	Grandeur	A1-2-3	S1-2-3	S4-5-6	SA1-2-3
019-00072-B	Taille 1	√			√
019-00072-K	Taille 2	√			√
019-00072-J	Taille 3	√			√
019-00073-B	Taille 1		√		
019-00073-K	Taille 2		√		
019-00073-J	Taille 3		√	√	

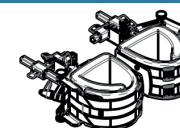

D - SUPPORT MULTI-AXES DOUBLE BUTÉE

Numéro de produit	Grandeur	A1-2-3	S1-2-3	S4-5-6	SA1-2-3
019-00070-B	Taille 1	√			√
019-00070-K	Taille 2	√			√
019-00070-J	Taille 3	√			√
019-00071-B	Taille 1		√		
019-00071-K	Taille 2		√		
019-00071-J	Taille 3		√		

8

SYSTÈME POUR JAMBE



STANDARD

Numéro de produit	Grandeur	A1-2-3	S1-2-3	S4-5-6	SA1-2-3
019-00061-B	Taille 1				√
019-00061-B-XL	Taille XL				√
019-00061-K	Taille 2				√
019-00061-K-XL	Taille 2XL				√
019-00061-J	Taille 3				√
019-00061-J-XL	Taille 3XL				√

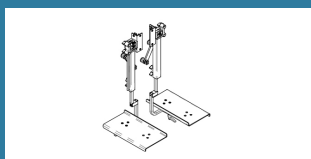

B-ABDUCTION

Numéro de produit	Grandeur	A1-2-3	S1-2-3	S4-5-6	SA1-2-3
019-00009-B	Taille 1				√
019-00009-B-XL	Taille XL				√
019-00009-K	Taille 2				√
019-00009-K-XL	Taille 2XL				√
019-00009-J	Taille 3				√
019-00009-J-XL	Taille 3XL				√

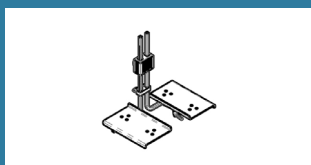

C-MULTI-AXES

Numéro de produit	Grandeur	A1-2-3	S1-2-3	S4-5-6	SA1-2-3
019-00022-B	Taille 1		√		
019-00022-K	Taille 2		√		
019-00022-J	Taille 3		√		

ENSEMBLE DE CONVERSION POUR SYSTÈME ABDUCTION

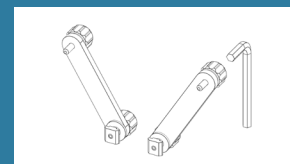

STANDARD

Numéro de produit	Grandeur	A1-2-3	S1-2-3	S4-5-6	SA1-2-3
019-00062-B	Taille 1				√
019-00062-K	Taille 2				√
019-00062-J	Taille 3				√

9

REPOSE-PIED

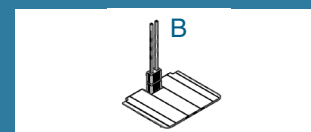

STANDARD

Numéro de produit	Grandeur	A1-2-3	S1-2-3	S4-5-6	SA1-2-3
019-00021-B	Taille 1		√		
019-00021-K	Taille 2		√		
019-00021-J	Taille 3		√		

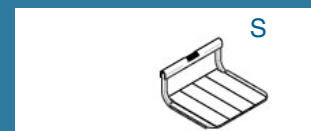

STANDARD

Numéro de produit	Grandeur	A1-2-3	S1-2-3	S4-5-6	SA1-2-3
019-00021-S				√	

10

TABLE

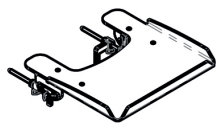

A-STANDARD

Numéro de produit	Grandeur	A1-2-3	S1-2-3	S4-5-6	SA1-2-3
019-00011-20 LEXAN CLAIR	20"	√	√		√
019-00011-22 LEXAN CLAIR	22"	√	√		√
019-00011-24D LEXAN CLAIR	24"	√	√		√
019-00011-24 LEXAN CLAIR	24"			√	
019-00011-26 LEXAN CLAIR	26"			√	
019-00011-28 LEXAN CLAIR	28"			√	
019-0001020 ABS NOIR	20"	√	√		√
019-00010-22 ABS NOIR	22"	√	√		√
019-00010-24D ABS NOIR	24"	√	√		√
019-00010-24 ABS NOIR	24"			√	
019-00010-26 ABS NOIR	26"			√	
019-00010-28 ABS NOIR	28"			√	



B-BOL D'ACTIVITÉ

Numéro de produit	Grandeur	A1-2-3	S1-2-3	S4-5-6	SA1-2-3
019-00049-20 LEXAN CLAIR	20"	√	√		√
019-00049-22 LEXAN CLAIR	22"	√	√		√
019-00049-24D LEXAN CLAIR	24"	√	√		√
019-00057-20 ABS NOIR	20"	√	√		√
019-00057-22 ABS NOIR	22"	√	√		√
019-00057-24 ABS NOIR	24"	√	√		√

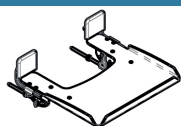

C-BLOQUEUR DE COUDE

Numéro de produit	Grandeur	A1-2-3	S1-2-3	S4-5-6	SA1-2-3
019-00065		√	√	√	√

11

DEMI-COUSSIN DE TABLE



Numéro de produit	Grandeur	A1-2-3	S1-2-3	S4-5-6	SA1-2-3
019-00046-20	20"	√	√		√
019-00046-22	22"	√	√		√
019-00046-24	24"	√	√	√	√
019-00046-26	26"			√	
019-00046-28	28"			√	

12

POIGNÉE DE MANUTENTION



Numéro de produit	Grandeur	A1-2-3	S1-2-3	S4-5-6	SA1-2-3
019-00002		√	√		√

13

MENTONNIÈRE COUSSINÉE



Numéro de produit	Grandeur	A1-2-3	S1-2-3	S4-5-6	SA1-2-3
019-00052		√	√	√	√

14

TABLIER COUSSINÉ



Numéro de produit	Grandeur	A1-2-3	S1-2-3	S4-5-6	SA1-2-3
019-00038-56	5 X 6 Lg.	√	√		√
019-00038-510	5 X 10 Lg.	√	√		√
019-00038-68	6 X 8 Lg.	√	√		√
019-00038-612	6 X 12 Lg.	√	√		√
019-00038-710	7 X 10 Lg.	√	√		√
019-00038-714	7 X 14 Lg.	√	√		√
019-00038-812	8 X 12 Lg.	√	√	√	√
019-00038-816	8 X 16 Lg.	√	√	√	√
019-00038-1016	10 X 16 Lg.	√	√	√	√
019-00038-1020	10 X 20 Lg.	√	√	√	√
019-00038-1318	13 X 18 Lg.	√	√	√	√
019-00038-1322	13 X 22 Lg.	√	√	√	√
019-00038-1624	16 X 24 Lg.	√	√	√	√
019-00038-1626	16 X 26 Lg.	√	√	√	√

15

APPUI-TÊTE VENTRAL



Numéro de produit	Grandeur	A1-2-3	S1-2-3	S4-5-6	SA1-2-3
019-00050-S	Taille 1	√	√		√
019-00050-M	Taille 2	√	√		√
019-00050-L	Taille 3	√	√		√

15

HARNAIS THORACIQUE



Numéro de produit	Grandeur	A1-2-3	S1-2-3	S4-5-6	SA1-2-3
019-00044-S	Petit	√	√		√
019-00044-M	Moyen	√	√	√	√
019-00044-L	Grand	√	√	√	√

17

SUPPORT DE PIED



Numéro de produit	Grandeur	A1-2-3	S1-2-3	S4-5-6	SA1-2-3
140-0001-1	2 1/2 X 5 1/2 Lg.	√	√		√
140-0001-2	3 X 6 3/4 Lg.	√	√		√
140-0001-3	3 1/2 X 7 1/2 Lg.	√	√	√	√
140-0001-4	3 3/4 X 8 1/2 Lg.	√	√	√	√
140-0001-5	4 X 9 1/2 Lg.	√	√	√	√
140-0001-6	4 1/4 X 10 1/2 Lg.	√	√	√	√
140-0001-7	4 3/4 X 12 Lg.	√	√	√	√
140-0001-8	5 X 13 Lg.	√	√	√	√

18

COURROIE POUR ORTEILS



Numéro de produit	Grandeur	A1-2-3	S1-2-3	S4-5-6	SA1-2-3
140-0001-1TS	SUPPORT DE PIED #140-00001-1	√	√		√
140-0001-2TS	SUPPORT DE PIED #140-00001-2	√	√		√
140-0001-3TS	SUPPORT DE PIED #140-00001-3	√	√	√	√
140-0001-4TS	SUPPORT DE PIED #140-00001-4	√	√	√	√
140-0001-5TS	SUPPORT DE PIED #140-00001-5	√	√	√	√
140-0001-6TS	SUPPORT DE PIED #140-00001-6	√	√	√	√
140-0001-7TS	SUPPORT DE PIED #140-00001-7	√	√	√	√
140-0001-8TS	SUPPORT DE PIED #140-00001-8	√	√	√	√



Synetik

1242 rue de Lanaudière, Joliette,
Québec, Canada
J6E 3P1

synetikergocare.com
info@synetikergocare.com
1 866 739-2400