

S4-5-6 VERTIFLEX | Order Form CAN 7.0

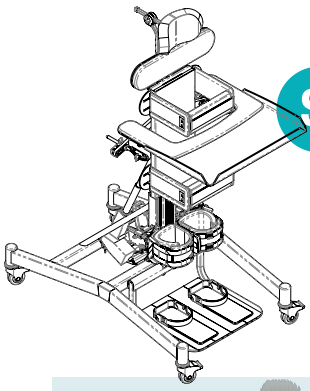

Company :
Quote :
PO Number :
Marked for :
Ship to :

Address :
City :
State :
Zip :
Phone :

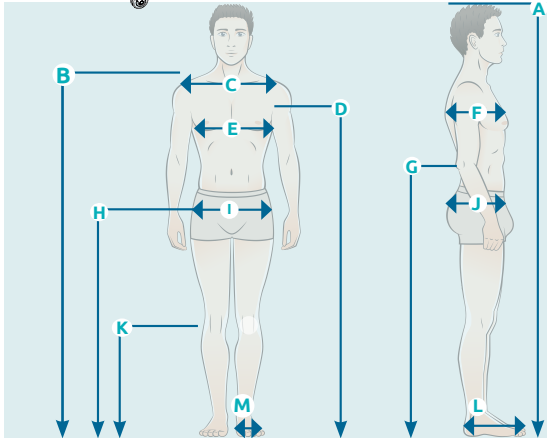

1 Required Measurement:

- A Floor - Head
- B Floor - Shoulder
- C Width - Shoulder
- D Floor - Axilla
- E Width - Axilla
- F Depth - Thorax
- G Floor - Elbow
- H Floor - Mid Hip
- I Width - Hip
- J Depth - Hip

- K Floor - Knee
 - L Length - Foot
 - M Width - Foot
- Comments:

HEIGHT	(D) Floor to axilla	SIZE 4		SIZE 5		SIZE 6	
		Max weight.: 250 pounds		Max weight.: 250 pounds		Max weight.: 250 pounds	
		Minimum	Maximum	Minimum	Maximum	Minimum	Maximum
		42"	52"	47"	57"	54"	64"

2 Starter Kit includes:

- Prone 2176 \$ (019-00023-SP)
 - Supine 2266 \$ (019-00023-SS)
- Base model includes:** • Base • Mast • Axilla support receiver • Axilla support receiver

3 Color: Black

General: (Mandatory accessories)

- Locking casters 198 \$ (019-00068)
- Electric tilt system 2183 \$ (019-00102)
- Planar pad 219 \$ (019-00038-BS)

Headrest (optional)

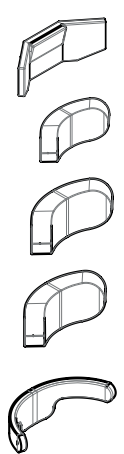

Model	Description	Dimensions	Price
<input type="checkbox"/> 022-00005	Multi-angle Adjustable Headrest (Height x Width)	022-00005-14 (4 1/2" x 7") 022-00005-16 (5" x 8") 022-00005-17 (6" x 9")	638 \$
<input type="checkbox"/> 022-00004	Headrest Soft Density "Shapeable Back Plate" (Height x Width)	022-00004-4 (3 1/2" x 6") 022-00004-5 (4 1/2" x 7") 022-00004-6 (5 1/2" x 8")	350 \$
<input type="checkbox"/> 022-00002	Headrest Rigid Density "Not Shapeable" (Height x Width)	022-00002-4 (3 1/2" x 6") 022-00002-5 (4 1/2" x 7") 022-00002-6 (5 1/2" x 8")	350 \$
<input type="checkbox"/> 022-00001	Headrest Soft Density "Not Shapeable" (Height x Width)	022-00001-4 (4" x 9 1/2") 022-00001-5 (5" x 10") 022-00001-6 (6" x 10 1/2")	350 \$
<input type="checkbox"/> 022-00003	Headrest Soft Density / Shapeable Laterals Low Profile (Height x Width) (3" x 5")		422 \$

S4-5-6 VERTIFLEX | Order Form CAN 7.0

Headrest Mount (Optional)

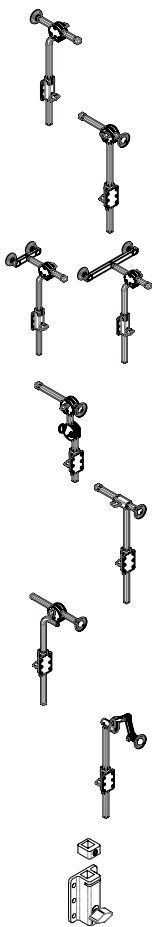

020-0004	Multi-axis Headrest Mount 45°	329 \$
020-0001	Straight Multi-axis Headrest Mount	329 \$
020-0005	Dual-attachment Multi-axis Headrest Mount 020-0005-4 4" Attachment Distance 020-0005-9 9" Attachment Distance	422 \$
020-0006	Flip-back Multi-axis Headrest Mount	467 \$
020-0007	Standard 90° Headrest Mount	467 \$
020-0009	Offset 90° Multi-axis Headrest Mount	467 \$
020-0008	Triple pivot Multi-axis Headrest Mount	467 \$
020-0015	Mounting Bracket Kit - Without Headrest Mount	218 \$

Foot (mandatory)

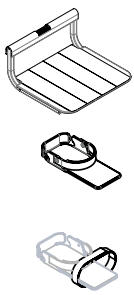

019-00021-S	Standard Footplate	467 \$
140-00001	Foot holder (pair) (Width x Depth) 140-00001-5 4" x 9 1/2" 140-00001-6 4 1/4" x 10 1/2" 140-00001-7 4 3/4" x 12" 140-00001-8 5" x 13"	194 \$
140-00001-(x)TS	Toe strap for foot holder (pair)	48 \$

Knee (mandatory)

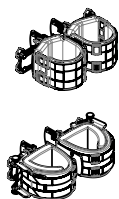

019-00033-J	Adjustable knee positioning with padded straps	617 \$
019-00073-J	Independent Knee Support - Double Lateral	752 \$

S4-5-6 VERTIFLEX | Order Form CAN 7.0

Hip (mandatory)

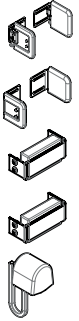

<input type="checkbox"/> 019-00043-J	Standard hip laterals				242 \$
<input type="checkbox"/> 019-00045-J	Swing away hip laterals				741 \$
<input type="checkbox"/> 019-00035	Rigid Padded Hip Strap				127 \$
<input type="checkbox"/> 019-00029	Soft Padded Hip Strap				127 \$
<input type="checkbox"/> 019-00008-S	Abduction support	<input type="checkbox"/> Small (s)	<input type="checkbox"/> Medium (m)	<input type="checkbox"/> Large (l)	359 \$

Upper Body (mandatory)

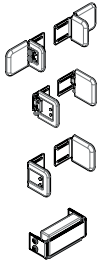

<input type="checkbox"/> 019-00042-J	Standard thoracic Support with elbow stops				207 \$
<input type="checkbox"/> 019-00034-J	Standard thoracic Support				717 \$
<input type="checkbox"/> 019-00041-J	Swing away thoracic support and Padded strap				512 \$
<input type="checkbox"/> 019-00028	Padded thoracic Strap				118 \$

Upper Body (optional)



<input type="checkbox"/> 019-00066-E	Independent thoracic support receiver package				346 \$
<input type="checkbox"/> 019-00044	Chest harness	<input type="checkbox"/> 019-00044-S Small	<input type="checkbox"/> 019-00044-M Medium	<input type="checkbox"/> 019-00044-L Large	315 \$

Shoulder



<input type="checkbox"/> 019-00006	Shoulder support (mandatory on Supine)				202 \$
------------------------------------	--	--	--	--	--------

Tray (mandatory)

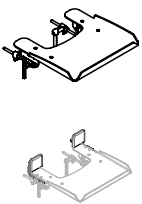

<input type="checkbox"/> 019-	Standard tray with half tray padding	<input type="checkbox"/> 019-00011 Lexan (clear)	<input type="checkbox"/> 019-00010 Abs (black)		809 \$
<input type="checkbox"/> 019-00065	Elbow Stop, Mounted on Tray (Pair)				273 \$

Other Accessories (optional)



<input type="checkbox"/> 019-00052	Hybrid Padded Chinrest				350 \$
------------------------------------	------------------------	--	--	--	--------